



**Mahogany Wine Rack
Assembly Instructions**

**Ten Column Double Deep Table &
Ten Column Double Deep Half Height Rack**



Congratulations! You have purchased the finest wine racking available anywhere. Properly assembled, these solid mahogany Vigilant wine racks will outlast even your finest wines. Please call toll free **888-812-4427** if you have any questions or problems.

Tools Required for Assembly:

- Electric drill or cordless screw gun
- 9/64" drill bit
- Phillips Head Screwdriver
- #2 Square drive bit
- Hammer, preferably rubber or soft-faced

Note: If you have chosen your wine rack to be finished without pre-drilled holes, you will need a pneumatic nail gun to properly assemble your rack

Parts List:

Before starting, carefully review the parts and quantities against the parts list to make sure you have everything you need. Then read through the instructions, taking time to familiarize yourself with the pieces and steps.

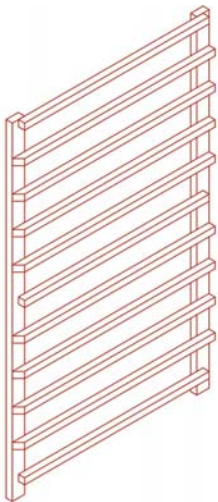

Left Side Ladder

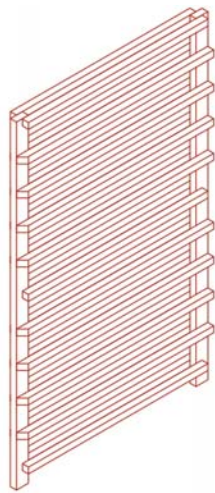

Double-Sided Ladder

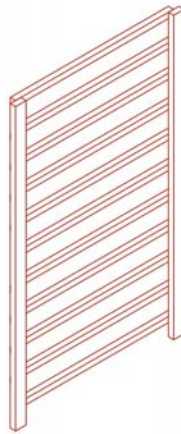

Right Side Ladder

- 6 Spacer Bars (45 3/4" long)
- 2 Single-Sided Ladders (40" long)
- 9 Double-Sided Ladders (40" long)
- 66 #8 Square Head Screws (1 1/2" long)
- 66 Screw Head Caps
- 6 #10 Tabletop Screws (1 1/4" long)



10 Column
Spacer Bar



Screw
Head Caps



#8 Square
Head Screw

Parts List



Tips: For Building Your Wine Racks

Before assembling your rack, line up all of your spacer bars. If any spacer bars have blemishes from shipping they can be used as back spacer bars, where they will not be seen.

If you are using a powered screw gun that has a clutch, make sure to set it at a low setting first until you find the right setting. If you have it set high it may over tighten and then split the wood.

Pre-drill all screw holes with a 9/64" drill bit. This makes it less likely for your wood to split. (The easiest way to do this is to follow the pre-drilled holes provided on certain pieces as your guide.)

When you screw through the spacer bar and into the ladder upright do not over tighten, especially on the end locations. Over tightening can cause your spacer bar to split.

Make sure you align the top of your spacer bar to the top of the spacer slat.

When drilling your rack into the wall it is easiest to drill through your top back spacer bar and into the wall stud.

When attaching racking to adjacent racking we recommend using clamps to hold the adjacent racks together before securing with screws.

The best placement for your screws, to secure adjacent racks is under all spacer bar locations. This keeps the screws hidden and keeps your rack secure and steady.

How to Care for Your Stained & Lacquered Wine Racks

Your Vigilant wine racks are built using the highest quality mahogany wood and finish available. When properly cared for, your wine racks will last longer than your finest bottles of wine. Here are a few tips on maintaining the quality and consistency of your racking.

Remove Dust: Dust build up from small airborne particles may scratch the surface if not removed correctly. Simply wipe the surface with a cloth dampened with a cleaning polish or mild detergent.

Clean: Fingerprints, cooking fumes, smoking residue, etc., accumulate on any surface. None of these contaminants will harm our Clear Guard™ finish, but they should be periodically removed to restore the finish to its original luster. Just wipe the surface with a cloth dampened with a non-wax containing polish or mild detergent solution. Avoid the use of ammonia based products or silicone oil, as they may cause damage if used over a long period of time.

Our Clear Guard™ finish is durable and resistant to most household spills. However, spills should be wiped up promptly to avoid potential problems.

Excessive prolonged exposure to direct sunlight, high temperatures and high humidity can cause damage to both the finish and the wood itself. These should be avoided.

Following these simple steps will keep your finished wine racks looking like new for many years.

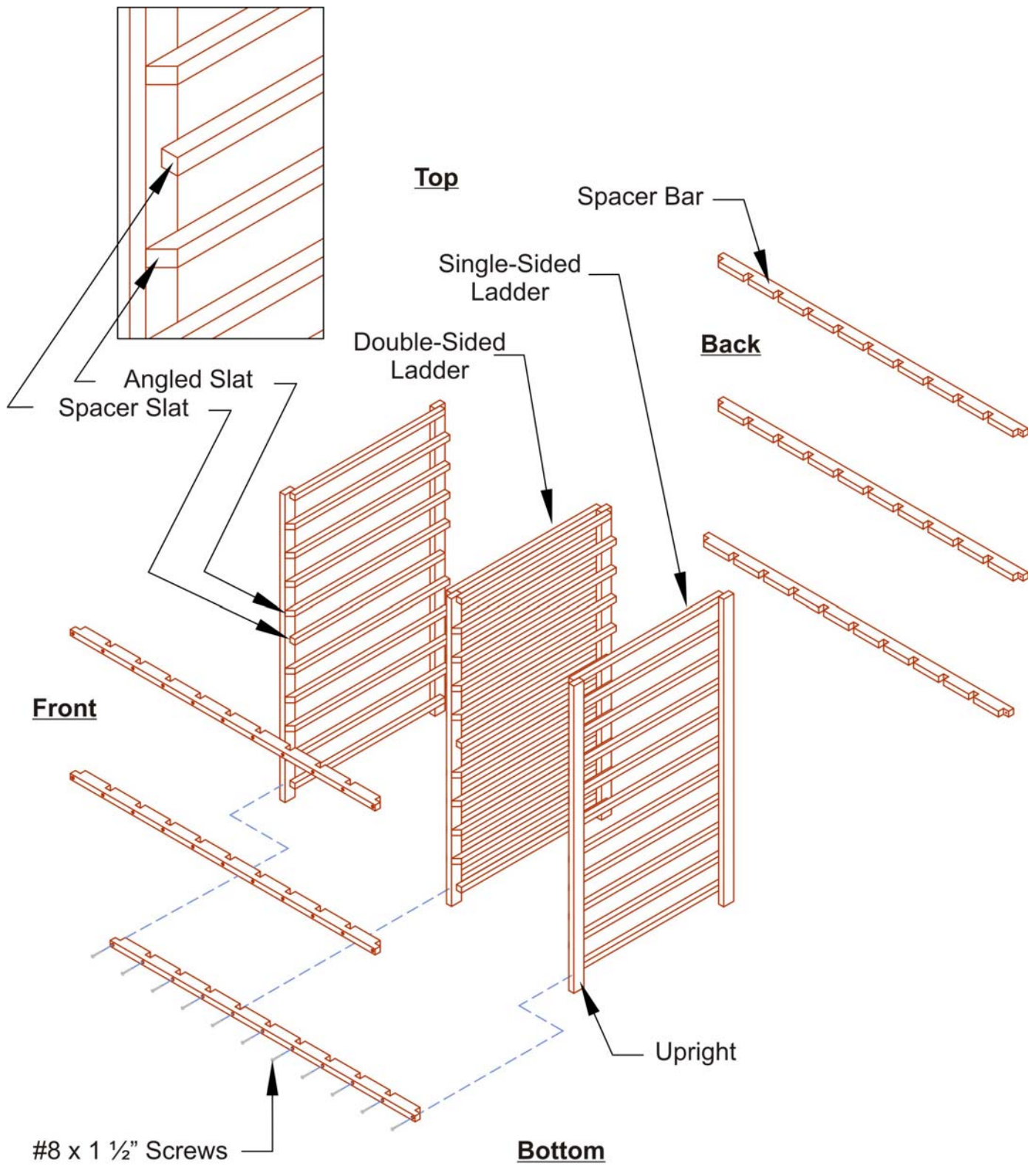

Exploded View

Steps to Assembly

Please see notes in instructions for special steps on assembling racking without pre-drilled holes.

1. Locate one of your double-sided ladders. You will notice that the top of the ladder has horizontal slats flush with the top of the uprights, while the bottom slats are set in 1 3/4" from the bottom of the uprights (**See Exploded View**). The ladder fronts are distinguished by slats that have an angled face, while the backs show the square ends of the horizontal slats. The other piece you need to locate is one of the spacer bars.

2. Set your double-sided ladder with the back on the floor (angled slats facing up) and fit your spacer bar on the front upright of your ladder by placing the dados (or grooves) of the spacer bar onto the upright (**Figure 1**). It may be necessary to tap the spacer bar lightly with a soft-faced hammer to fit, taking care to align the spacer bar vertically with the spacer slat behind it.

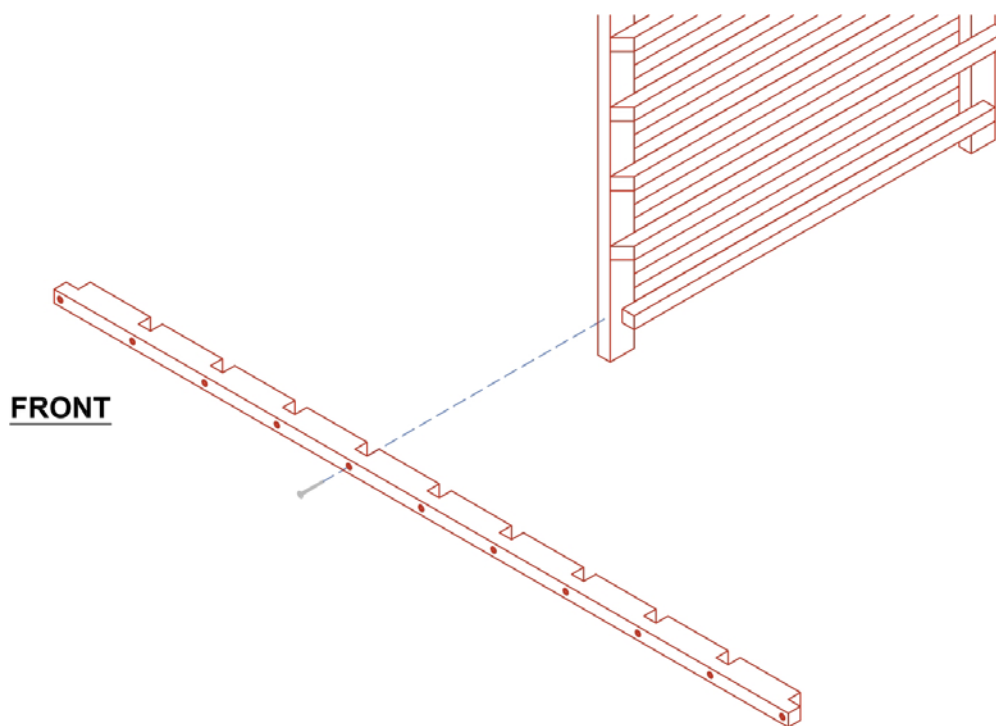

Figure 1

3. Pre-drill a screw hole through the pre-drilled hole provided in the spacer bar and into the ladder upright using a 9/64" drill bit. Change to the square drive bit and drive a screw into the pre-drilled hole. Be sure that the screw head sinks below the surface.

Note: For racks without pre-drilled holes, attach spacer bar using nail gun in step 3.

4. Take another double-sided ladder, setting it on its back next to the first one and slide it into the next open middle dado (or groove). Align the spacer bar with the spacer slat as before. ****Pre-drill through your screw hole and then secure with one of the screws provided.**

****Note: For racks without pre-drilled holes, attach spacer bar using nail gun in step 4.**

5. Repeat step 4 until all (9) double-sided ladders are in place.

6. Set the two single-sided ladders with the backs on the floor (angled slats facing up) and into the open end rabbet (or slot) locations (**Figure 2**). Make sure that the slat sides of the ladders face inward toward the other ladders. Align the spacer bar at the spacer slat location. Pre-drill through the existing screw holes on your spacer bar and into the ladder uprights. Secure both ladders with screws as before.

****Note: For racks without pre-drilled holes, attach spacer bar using nail gun in step 6.**

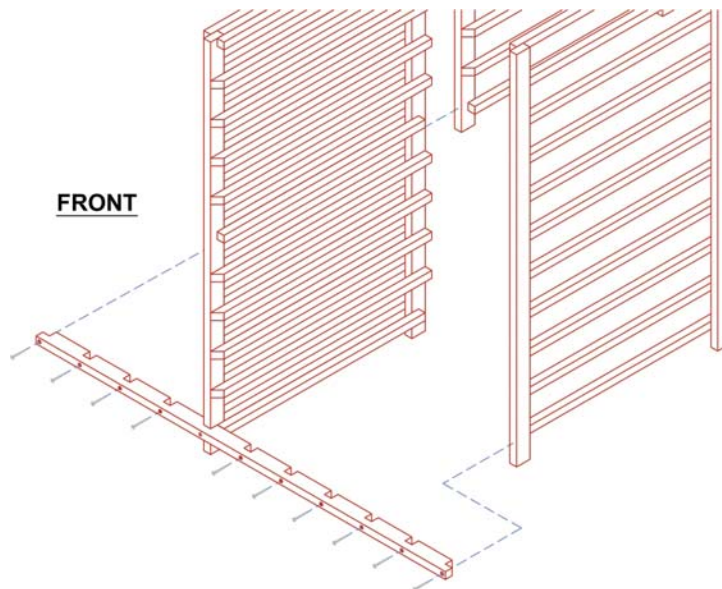

Figure 2

7. At this point all (11) ladders should be attached to the spacer bar (**Figure 3**). Set another spacer bar over the next spacer slat location tapping gently with a hammer to ensure a proper fit on all uprights.

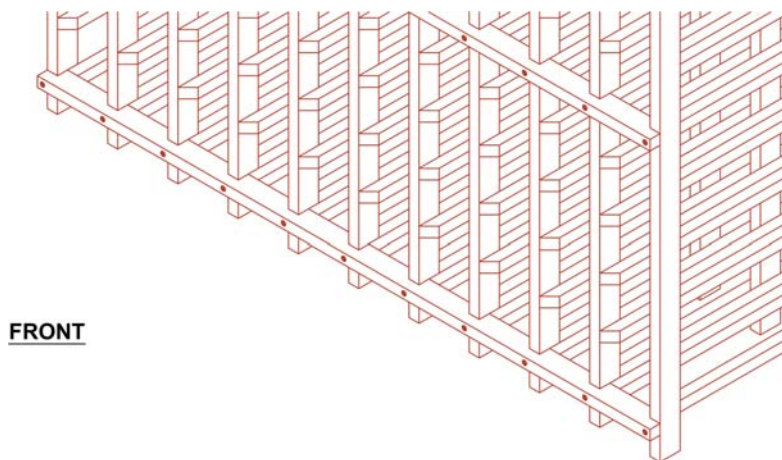

Figure 3

8. Align the spacer bar with all the spacer slats behind it. ****Pre-drill through the existing screw holes in your spacer bar and into the uprights. Secure with the screws provided.**

****Note: For racks without pre-drilled holes, attach spacer bar using nail gun in step 8.**

9. Add the third spacer bar, repeating steps 7 & 8.

10. Carefully flip the assembly onto its front. Attach the remaining spacer bars to the back in the same manner as the front. Be sure to align all spacer bars with the spacer slat locations and ****pre-drill your screw holes into the uprights before attaching with screws.**

****Note: For racks without pre-drilled holes, attach spacer bar using nail gun in step 10.**

11. Stand your assembly up and place screw caps onto the heads of all front screws.

Note: No screw caps are needed when nail gun is used.

12. Your table is now complete and ready to be moved to its final location. The table should be placed with its back against a wall and be shimmed to level, front to back and side to side.

13. Attach your rack to the wall by drilling through at least one back spacer bar and into two wall stud locations then fasten securely with wood screws (not provided).

***Failure to attach the rack to the wall could result in the rack tipping over. When fully loaded with wine your rack will weigh 600lbs.*

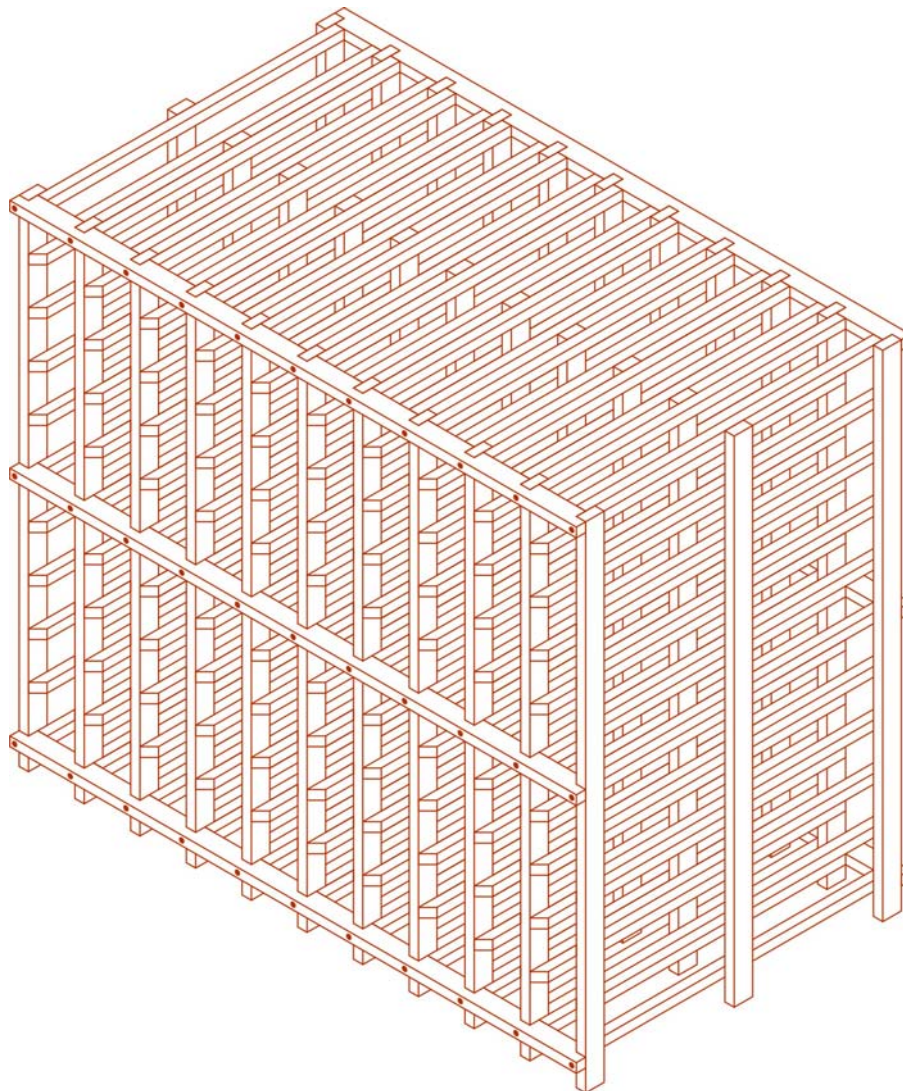

Finished Wine Table Base

Additional installation questions?
Contact us:



VIGILANT, INC.
85 Industrial Park Drive
Dover, NH 03820
Toll Free 1-888-812-4427
Outside US 1-603-285-0400
Fax 1-603-285-0420
email: info@vigilantinc.com
On the web www.vigilantinc.com