



**Wine Rack
Assembly Instructions
Solid Rectangular Bin**



Classic Series

Estate Series

Congratulations! You have purchased the finest wine racking available anywhere. Properly assembled, these Vigilant wine racks will outlast even your finest wines. Please call toll free **888-812-4427** if you have any questions or problems.

Tools Required for Assembly:

- Phillips Head Screwdriver
- Hammer, preferably rubber or soft-faced

Parts List:

Before starting, carefully review the parts and quantities against the parts list to make sure you have everything you need. Then read through the instructions, taking time to familiarize yourself with the pieces and steps.

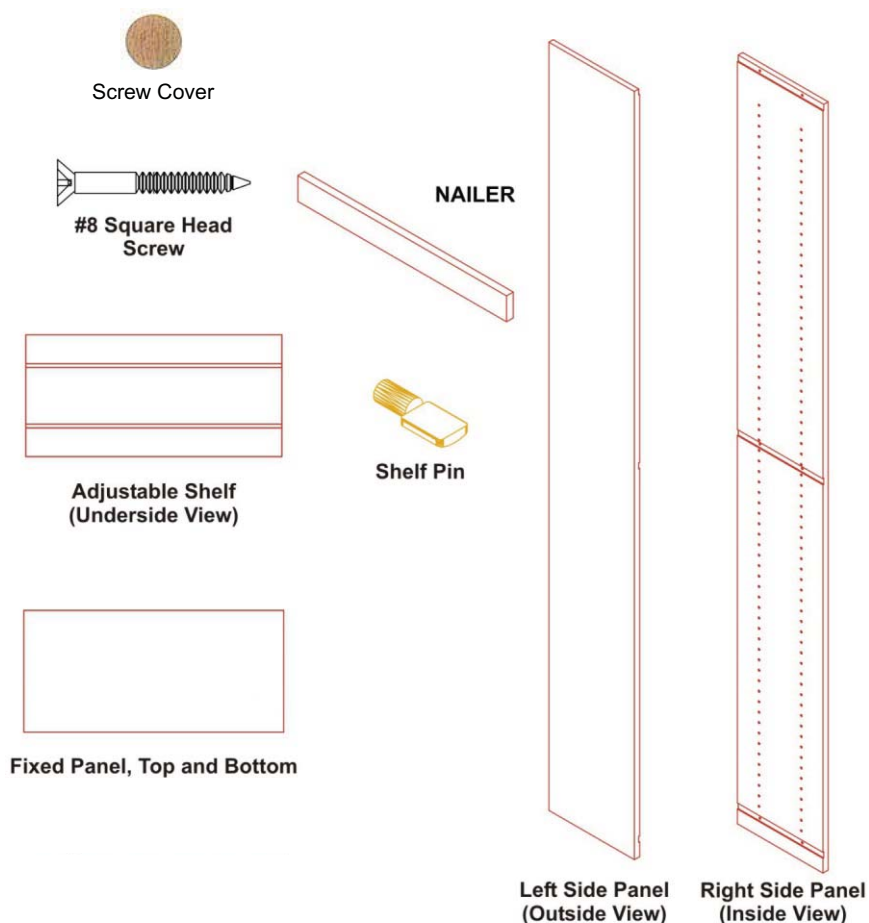

Classic Series (77 1/2" high)

- 1 Top Panel (25 9/32" long)
- 1 Bottom Panel (25 9/32" long)
- 5 Adjustable Shelves (24 29/32" long)
- 1 Fixed Shelf (25 9/32" long)
- 2 Side Panels (77 1/2" long)
- 20 Shelf Pins
- 2 Nailers
- 16 #8 Square Head Screws (1 1/2" long)
- 12 Screw Head Caps (optional)

Estate Series (92 1/2" high)

- 1 Top Panel (25 9/32" long)
- 1 Bottom Panel (25 9/32" long)
- 1 Fixed Shelf (25 9/32" long)
- 6 Adjustable Shelves (24 29/32" long)
- 2 Side Panels (92 1/2" long)
- 24 Shelf Pins
- 2 Nailers
- 16 #8 Square Head Screws (1 1/2" long)
- 12 Screw Head Caps (optional)

Parts List

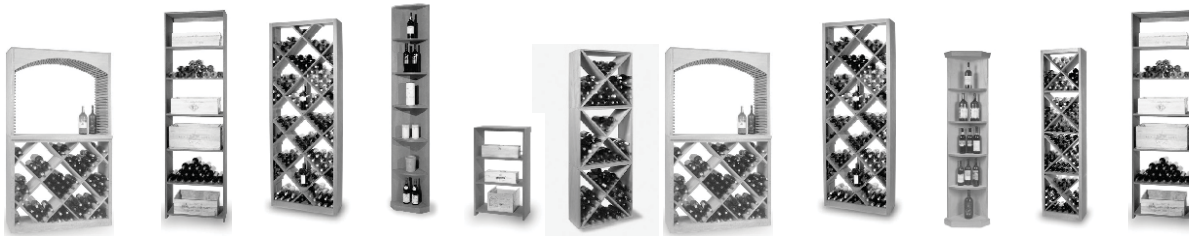

Tips: For Building Your Bins and Cases

Do not use a power drill when tightening your screws. If you do you could pierce the outside of the wood.

Before assembling your wine storage bin or case place a blanket down. You want a clean and scratch free surface during assembly.

It is recommended to use glue at joints when ever possible to make the joint stronger.

Pre-drill all screw holes with a 9/64" drill bit. This makes it less likely for your wood to split. (The easiest way to do this is to follow the pre-drilled holes provided on certain pieces as your guide.)

When assembling your case work make sure that all front edges are flush to one another.

Align the front of your case work to the front spacer bar of the adjacent racking. (This is true for every item except the Quarter Round, where you will line the filler strip up to the front of the spacer bar.)

When lining your case work up with adjacent racking, it may be pulled out slightly from the wall and therefore not able to be attached to a wall stud. We recommend securing it to the adjacent racking on both sides or purchasing L-Brackets from your hardware store to attach it to the wall.

When attaching your assembly to adjacent racking or other case work we recommend using clamps to hold the pieces together before securing with screws.

When attaching case work to racking, drill a hole through the side at a discrete location like the very top or below a shelf.

If you are attaching a 10 Column Soffit Arch above a Diamond Bin Table Base, it is recommended to not attach the outer face frame on the Diamond Bin Table Base. This will allow easy access to the diagonal panels for easy removal when attaching the arch through the top of the table base.

How to Care for Your Stained & Lacquered Wine Racks

Your Vigilant wine racks are built using the highest quality wood and finish available. When properly cared for, your wine racks will last longer than your finest bottles of wine. Here are a few tips on maintaining the quality and consistency of your racking.

Remove Dust: Dust build up from small airborne particles may scratch the surface if not removed correctly. Simply wipe the surface with a cloth dampened with a cleaning polish or mild detergent.

Clean: Fingerprints, cooking fumes, smoking residue, etc., accumulate on any surface. None of these contaminants will harm our Satin lacquer finish, but they should be periodically removed, to restore the finish to its original luster. Just wipe the surface with a cloth dampened with a non-wax containing polish or mild detergent solution. Avoid the use of ammonia based products or silicone oil, as they may cause damage if used over a long period of time.

Our Satin lacquer finish is durable and resistant to most household spills. However, spills should be wiped up promptly to avoid potential problems.

Excessive prolonged exposure to direct sunlight, high temperatures and high humidity can cause damage to both the finish and the wood itself. These should be avoided.

Following these simple steps will keep your finished wine racks looking like new for many years.

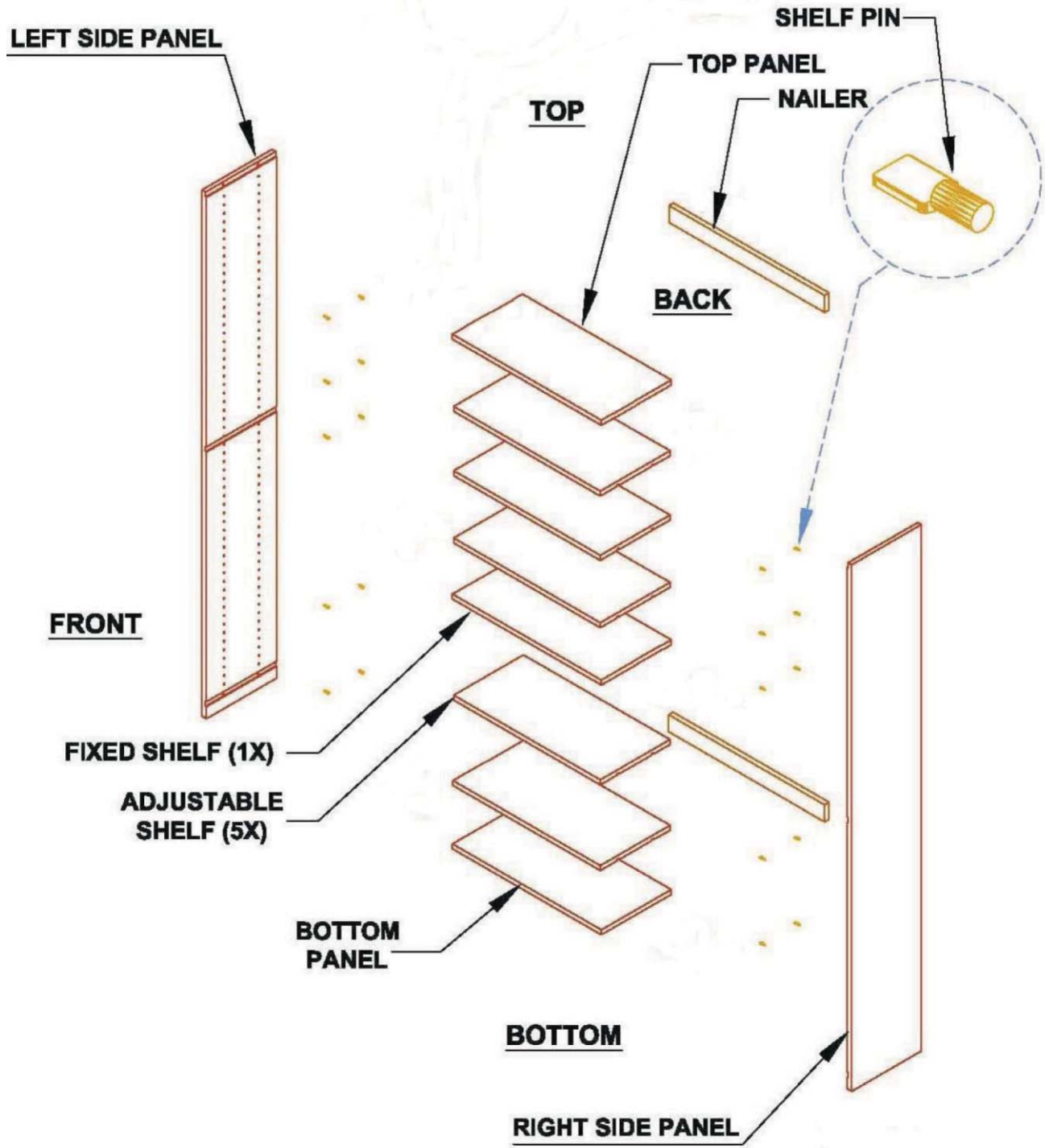

Exploded View

Steps to Assembly

1. Locate your top, bottom, side and fixed panels (**See Parts List**).
2. Locate the pre-drilled holes on the left side panel and attach to the top, bottom and fixed panels using the screws provided (**Figure 1**).

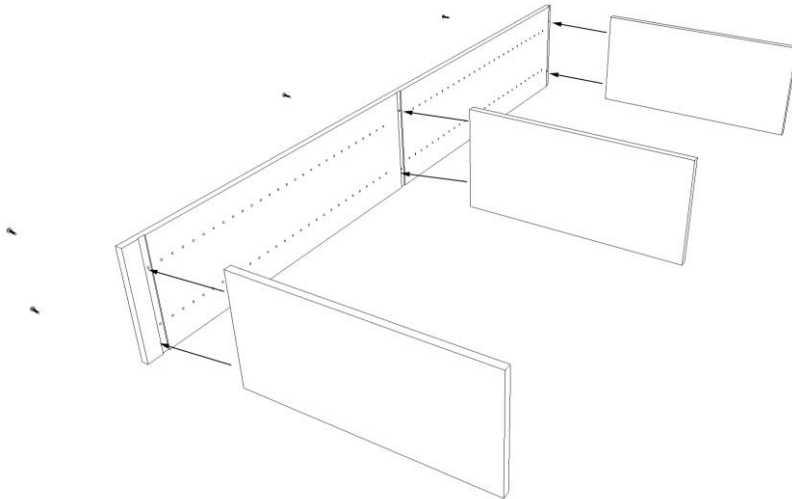

Figure 1

3. Attach the right side panel to the top, bottom and fixed panel using the pre-drilled holes and screws provided (**Figure 2**).

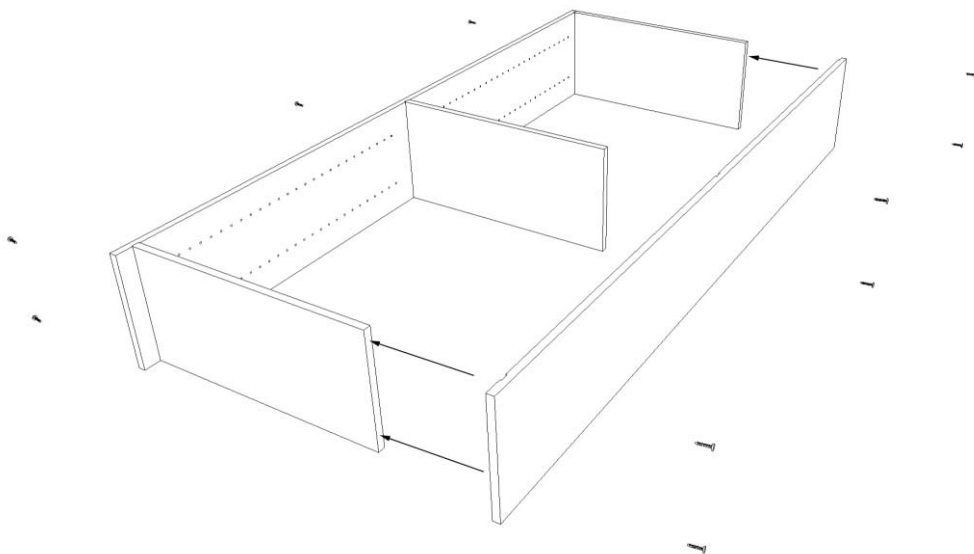

Figure 2

4. The outer frame should now be assembled and stood upright.

5. Locate the two nailers. Attach one nailer to the upper back of the solid rect. bin flush to the top using the screws provided. Attach the second nailer to the lower back of the side panels flush to the lower back of the solid rect. bin flush to the bottom of the right and left panels. (**Figure 3**)

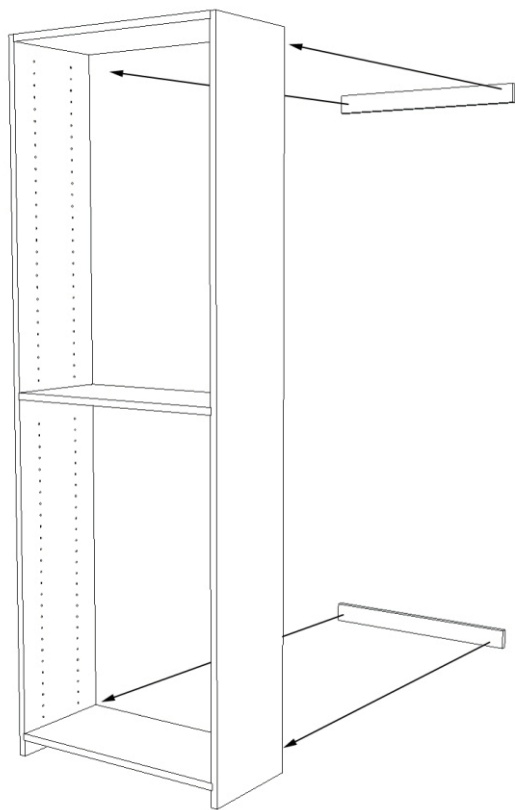

Figure 3

6. Locate the shelf pins and insert them into the holes in the frame where you would like your shelves to be. Locate the shelves and insert them into their designated spots (**Figure 4**).

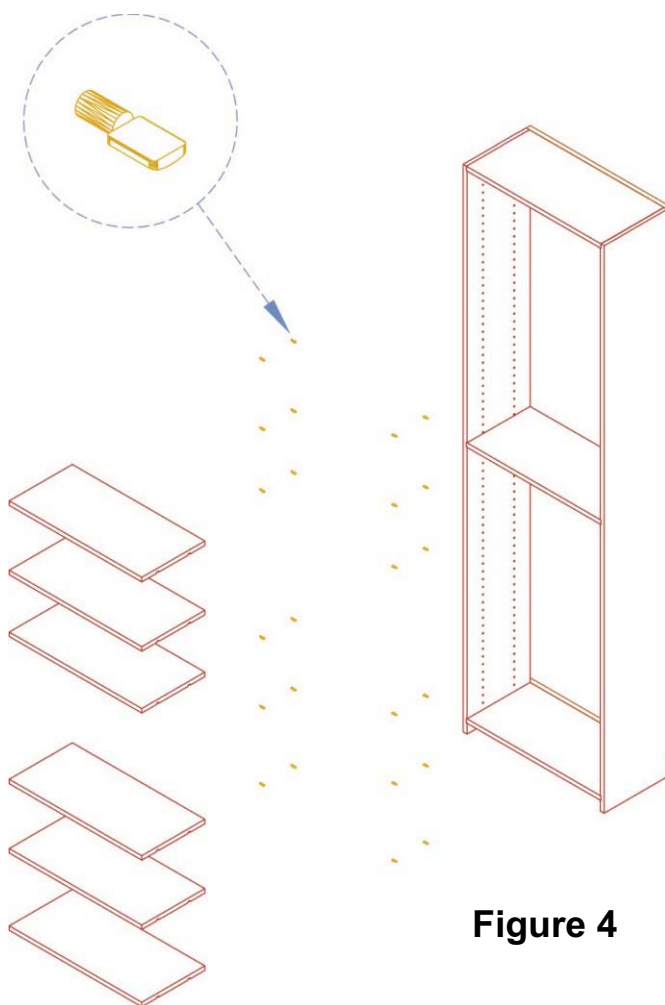
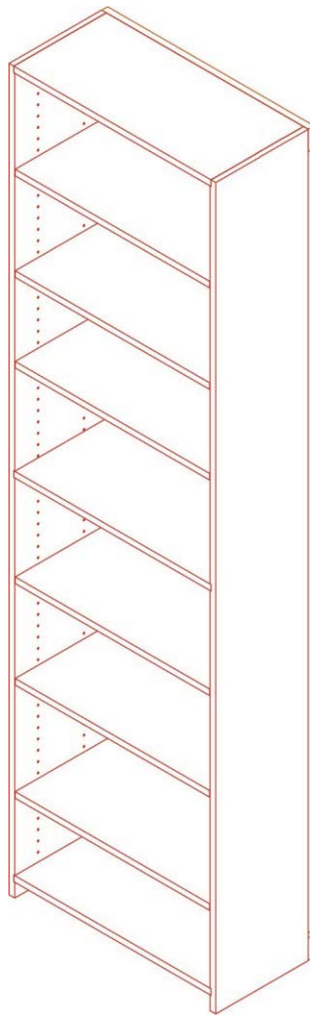

Figure 4

7. Your solid rectangular bin is now complete and ready to be moved to its final location. The rack should be placed with its back against a wall and be shimmed to level, front and back and side to side.

8. Attach the rect. bin to the wall by drilling through the two nailers you attached at the top and bottom into wall stud locations then fasten securely with wood screws (not provided).

***Failure to attach the rack to the wall could result in the rack tipping over. When fully loaded with wine your rack will weigh 255lbs. for the Classic Series and 300lbs. for the Estate Series.*



Finished Solid Rectangular Bin

Additional installation questions?
Contact us:



VIGILANT, INC.
85 Industrial Park Drive
Dover, NH 03820
Toll Free 1-888-812-4427
Outside US 1-603-285-0400
Fax 1-603-285-0420
email: info@vigilantinc.com
On the web www.vigilantinc.com